

Flow

hand-drawn, cord-, electrically operated
for consistent pleats in curtains

The ideal solution for classic elegance

hand-drawn, cord-, electrically operated
for consistent pleats in curtains

elegant & stylish

The Qurails Flow System keeps pleats in curtains consistent. It can be used with small and wide channel tracks and, because of the broad assortment of components, it can be integrated in hand-drawn, cord-pulled and electrically operated systems. The Flow System can also be used with curved curtain tracks..

Flow gliders

Flow gliders rotate on a cord and are placed along a track at set distances of 60 or 80 mm. Flow gliders can be used with the following Qurails track profiles:



Profile 2000 series:
2014-12
rotating glider on cord
small channel 60 or 80 mm



Profile 4000, 5000, 6000 series:
4014-12
rotating glider on cord
wide channel 60 or 80 mm

Curtain tape

The Qurails Flow System has two types of curtain tape for distances of 60 mm and 80 mm, respectively. See application example “Curtain tape” on the next page for dimensions of the two types of curtain tape for pleat folds of 200%, 250% and 280%.

The tape is coated with an adhesive so that it can be ironed onto the curtain fabric before being permanently sewn. In this way, it will not shift in position while the curtains are being made.

In addition, red markings have been placed in the tape at points where curtain hooks can be placed.

Curtain hooks

Curtain hooks 2021-FL can be inserted in the pockets by the markings matching the chosen pleat fold.



2021-FL
Flow hook

flow



Confection

Curtain package

Package height: up to 3 metres because the pleat appearance at the bottom of the curtain.

Package width: up to 5 metres (single package) making a total of 10 metres for a pair.

Sewing advice

Allow a minimum of 5 mm free space between the underside of the chosen track and the top edge of the curtain. It is important to do this to stop the curtain from catching.

The curtain tape should be ironed on first and the permanently sewn with the narrow strip facing upwards.

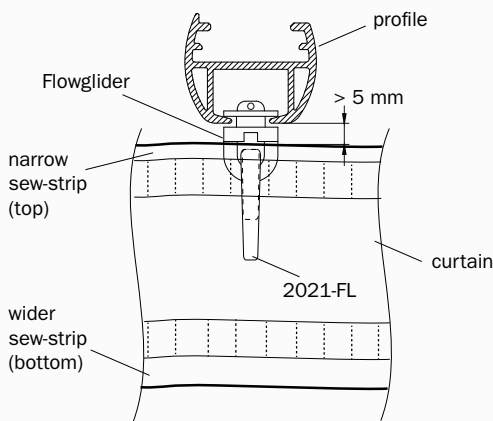

Application example



Overview of various hand, cord and electrically operated situations. In the diagrams, the Flow parts are always shown with a symbol.

Electric middle closing

Middle closing with out overlap 5600/6200

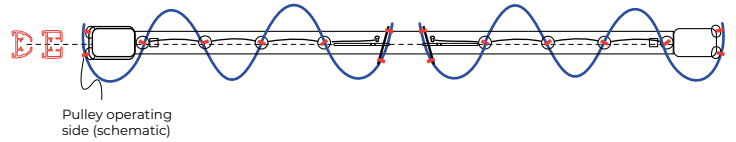

Hand-drawn middle-closing

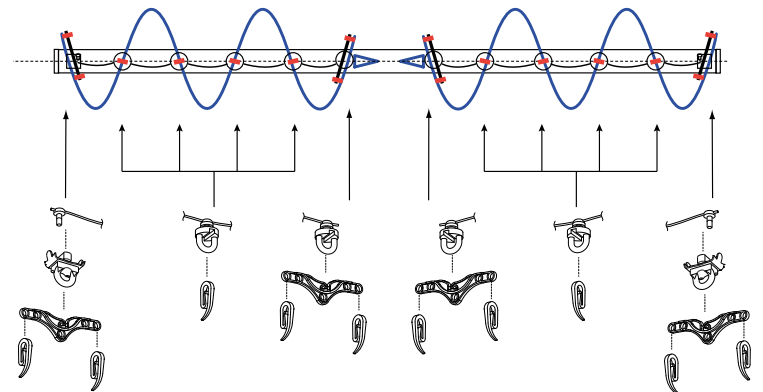

Curtain tape

4014-22-060 for the purpose of 4014-12-060 glider
60 mm band
200% every 12 pockets
250% every 15 pockets
280% every 17 pockets

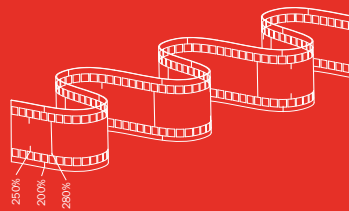

4014-22-080 for the purpose of 4014-12-080 glider
80 mm band
200% every 16 pockets
250% every 20 pockets
280% every 23 pockets

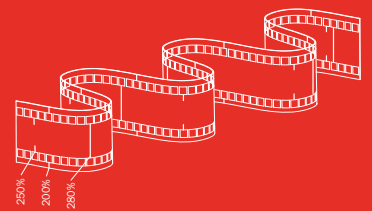

Pleat sizes

4014-22-060
band Flow for 60 mm gliders with adhesive

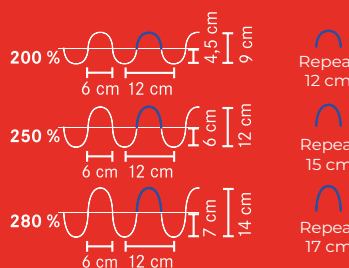

4014-22-080
band Flow for 80 mm gliders with adhesive

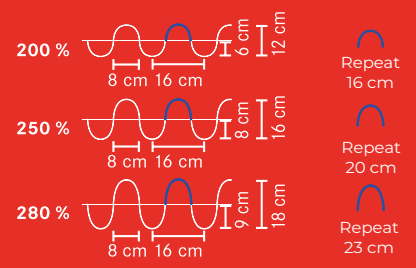

Standard parts



Curtain transport

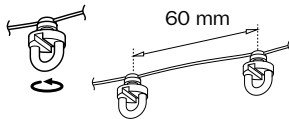

2014-12-060
rotating glider on cord
Flow small channel
60mm

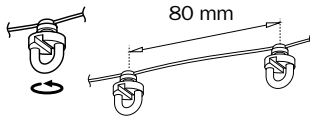

2014-12-080
rotating glider on cord
Flow small channel
80mm

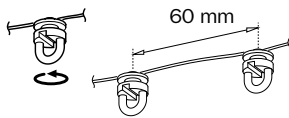

4014-12-060
rotating glider on cord
Flow wide channel
60mm

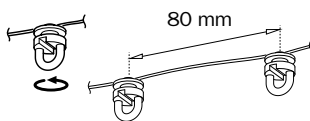

4014-12-080
rotating glider on cord
Flow wide channel
80mm



4074-10FL
pilot hook Flow white



2021-FL
curtain hook Flow white



2001
twist end stop
white / grey / black



4001
end stop
white / grey / black

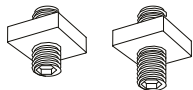

4002-08 5100 / 5300
4002-16 5600 / 6200
internal end stop



6009
PRS glider, used as spacer
behind overlap bracket

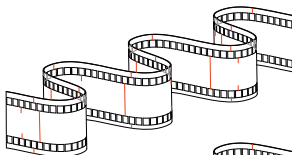

4014-22-060
band Flow for 60 mm
glider with adhesive

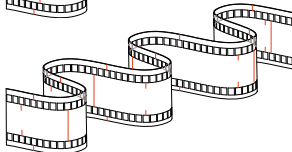

4014-22-080
band Flow for 80 mm
glider with adhesive

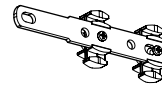

4075-1000
carrier without overlap,
a.o. for draw rod
white / natural metallic / black

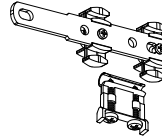

5175-3010
carrier with overlap
5100/5300 Flow
white / natural metallic

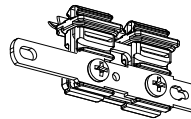

5675-3010
carrier 5600 without overlap
white / natural

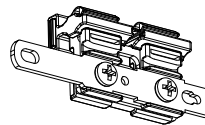

6275-3010
carrier without overlap
6200 Flow
white / natural metallic / black

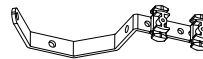

4074-30FL
carrier with overlap
Flow
white / natural metallic / black

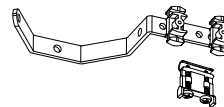

5174-30FL
carrier with overlap
5100/5300 Flow
white / natural metallic

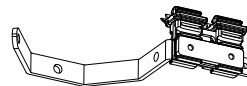

5674-30FL
carrier with overlap
5600 Flow
white, natural metallic

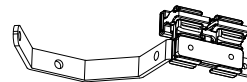

6274-30FL
carrier with overlap Flow
white / natural metallic / black

Accessories



2004
brake glider
white / black



1220
draw rod 100, 125, 150, 200 of
300 cm white / natural metallic
/ black

Technical specifications are subject to change without prior notice. Parts suitable for all rails, unless otherwise indicated.

Qurails®
Open a new experience