



# 5300

cord-operated

for sheers or medium-weight curtains

**Stable track with a slim look design**

# 5300



## cord-operated

for sheers or medium-weight curtains

## stable & slim-looking

The Qurails 5300 track is a stable, slim-look design cord-operated track. The curtains glide smoothly virtually without sound. Using the cord to open and close the curtains keeps the fabric clean. A very popular track that can be used in a wide variety of situations, such as private homes, but also in office buildings.

- The ideal track for sheers or medium-heavy curtains.
- Easy to bend and exceptional quality.
- Can be forward or reverse bent in different radii.
- Compatible with the Qurails Flow System for regularly pleated curtains.
- The cords can run through enclosed channels to ensure they remain less visible and cannot tangle.
- Silent and smooth running, also round bends.
- Keeps your curtains cleaner.



### Standard colours

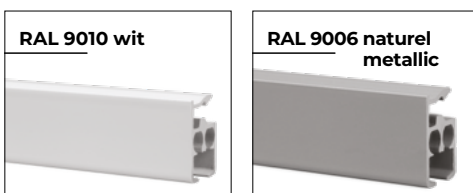

High quality, wear-resistant coating, highly colourfast, UV-resistant.  
Other RAL colours & special coatings on request.

### Features

Material:	aluminium
Colour:	white, natural metallic
Dimensions:	24 x 16 mm
Weight profile:	345 gr/m
Mounting:	wall or ceiling

## Profile/ gliderspecifications

### Aluminium profile:

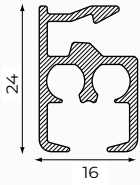

### Glider:

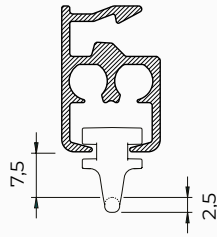

### Colours with RAL code and lengths (m):

	RAL	4	5	6	7
white	9010			•	•
natural metallic	9006			•	

### Mounting surface:

- wood
- masonry/concrete

### Bracket type:

- ceiling bracket
- wall bracket
- spacer bracket

### Bending:

bending radius	bending tool
R 15 cm	1015
R 25 cm	1015
R > 100 cm	1018

R 15 cm

R > 100 cm

## Flow

The Qurails Flow System keeps pleats in curtains consistent. It can be used with small and wide channel tracks and, because of the broad assortment of components, it can be integrated in hand-drawn, cord-pulled and electrically operated systems.

The Flow System can also be used with curved curtain tracks. For further information, see the [Flow product data sheet](#).

## Specification guide

### Material

- Aluminium EN AW-6060-T66.
- Anodised in accordance with the Qualanod standard.
- Powder coated in accordance with the Qualicoat standard.

## Mounting



Ceiling mounting with ceiling bracket 5350

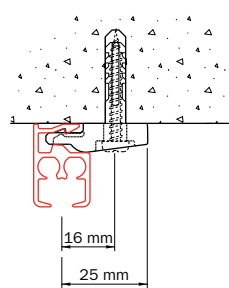

Ceiling mounting with double bracket 2216 and ceiling bracket 5350

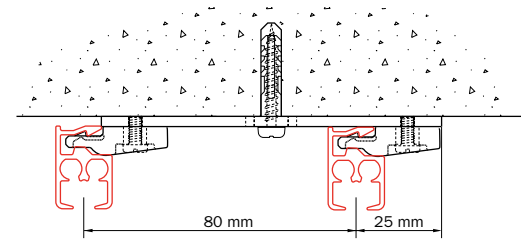

Wall mounting with wall bracket 5351

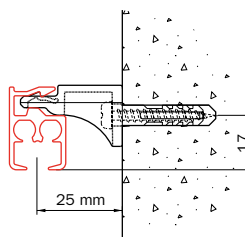

Method to release the 5300 from wall bracket 5351

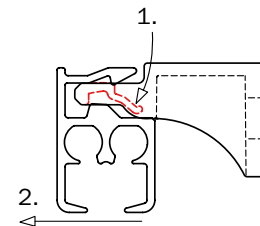

Wall mounting with extension bracket 2015 and ceiling brackets 5350

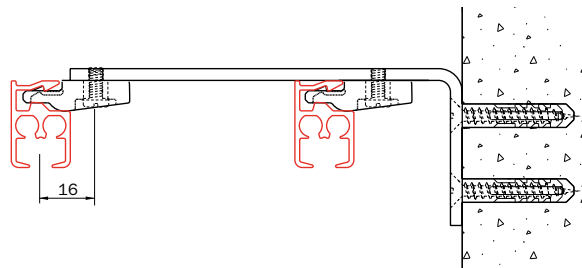

[mm]	a	b	c	d	e	f
2015-05	50	-	6.5	40	16	3
2015-07.5	75	47	6.5	40	16	3
2015-10	100	72	6.5	40	16	3
2015-15	150	72	6.5	40	16	3
2018-15	150	57 / 57	6	80	20	4
2019-20	200	80	6.5	60	20	4
2019-25	250	80	6.5	60	20	4
2019-30	300	80	6.5	60	20	4

## Combination example

Application of synthetic rail connector 2152 in the rear of the 5300

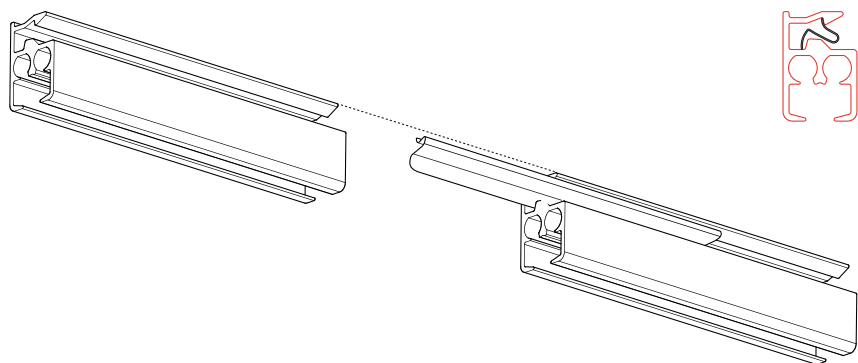

## Exploded view

Example of a middle-closing system, with gliders 4010 en overlap bracket 4074-1000

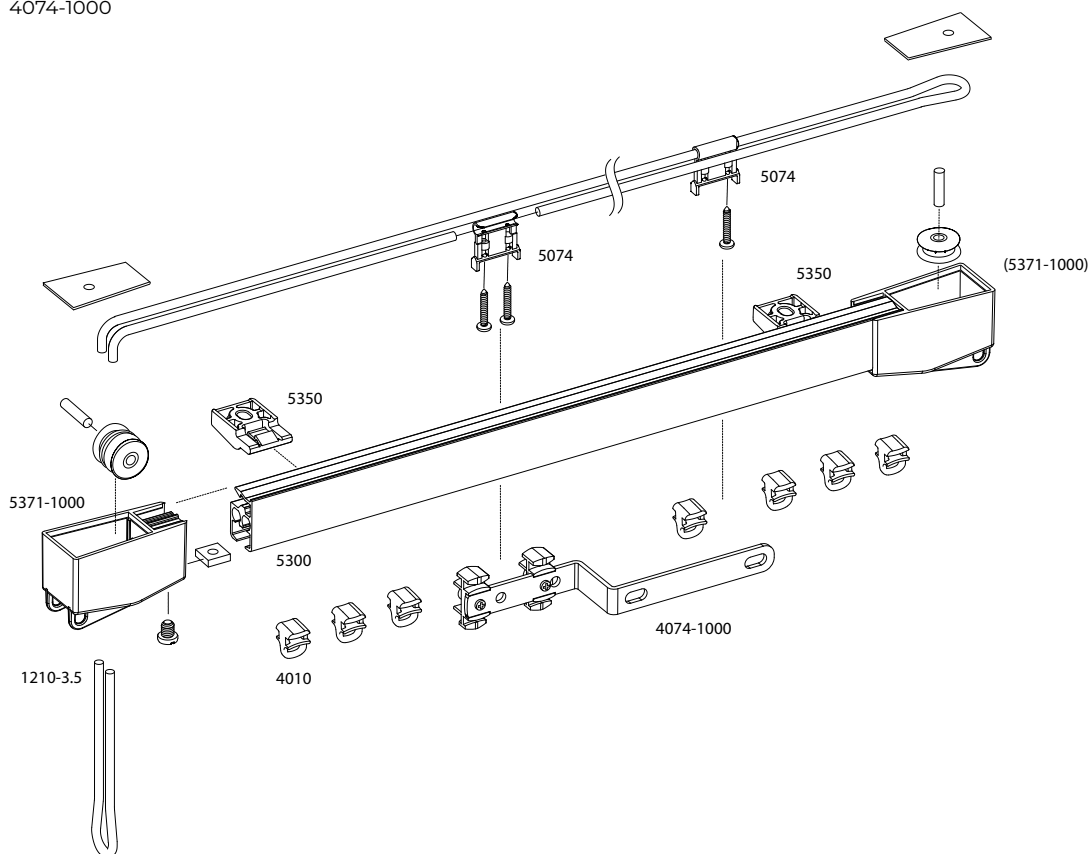





## Standard parts

### Curtain transport

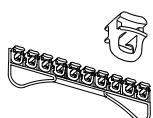

4010  
glider  
white / grey / black

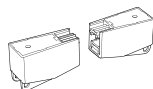

5371-1000  
pulley set  
white / grey



5074  
pilot runner  
white

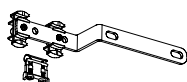

5174-3000  
carrier with  
overlap white /  
natural metallic/  
black

### Mounting



5350  
ceiling bracket  
white / black



5351  
wall bracket  
white

### Accessories

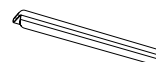

2152  
connecting bridge



1203-13  
cord weight  
white / grey / black

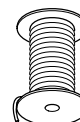

1210-3.5  
cord 3.5mm white /  
black

## Optional parts

### Curtain transport



4003  
spring stop plastic  
requires punch hole  
white



4007  
rotating glider white/  
grey / black



4010-50  
glider white with  
plastic hook 2023



4012  
click-in glider  
white



4020  
heavy duty glider  
white / grey / black

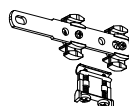

5175-3010  
carrier without  
overlap white /  
natural metallic /  
black



2020  
double hook  
white



2021-FL  
G-Hook  
white



2022  
curtain hook  
white



2023  
curtain hook  
white



2024-55  
adjustable sew in  
hook white 55mm



2024-95  
adjustable  
sew in hook  
white 95mm

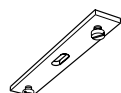

2216  
double bracket  
white / natural  
metallic / black  
(excl. 5350)

### Mounting

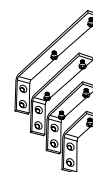

2015  
extension bracket  
5, 7.5, 10 of 15 cm  
white / natural  
metallic / black (excl.  
5350)

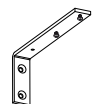

2018  
extension bracket  
heavy duty 15 cm  
white / natural metallic  
(excl. 5350)

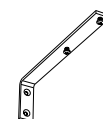

2019  
extension bracket heavy  
duty 20, 25 of 30 cm  
white / natural metallic /  
black (excl. 5350)

### Accessories



1201  
cord tensioner  
white

Technical specifications are subject to change without prior notice.

**Qurails**<sup>®</sup>  
Open a new experience