

# Flow

hand-drawn, cord-, electrically operated  
for consistent pleats in curtains

---

---

**The ideal solution for classic elegance**

## hand-drawn, cord-, electrically operated

for consistent pleats in curtains

### elegant & stylish

The Qurails Flow System keeps pleats in curtains consistent. It can be used with small and wide channel tracks and, because of the broad assortment of components, it can be integrated in hand-drawn, cord-pulled and electrically operated systems. The Flow System can also be used with curved curtain tracks..

#### Flow gliders

Flow gliders rotate on a cord and are placed along a track at set distances of 60 or 80 mm. Flow gliders can be used with the following Qurails track profiles:



**Profile 2000 serie:**  
**2014-12**  
rotating glider on cord  
small channel 60 or 80 mm



**Profile 4000, 5000, 6000 serie:**  
**4014-12**  
rotating glider on cord  
wide channel 60 or 80 mm  
\* with the exception of 4900



**2021-FL**  
Flow hook

#### Curtain tape

The Qurails Flow System has two types of curtain tape for distances of 60 mm and 80 mm, respectively. The dimensions of the two types of curtain tape for pleat folds of 200%, 250% and 280% are given in the adjacent table.

The tape is coated with an adhesive so that it can be ironed onto the curtain fabric before being permanently sewn. In this way, it will not shift in position while the curtains are being made.

In addition, red markings have been placed in the tape at points where curtain hooks can be placed.

Curtain hooks 2021-FL can be inserted in the pockets by the markings matching the chosen pleat fold.

flow



## Confection

### Curtain package

Package height: up to 3 metres because the pleat appearance at the bottom of the curtain.

Package width: up to 5 metres (single package) making a total of 10 metres for a pair.

### Sewing advice

Allow a minimum of 5 mm free space between the underside of the chosen track and the top edge of the curtain. It is important to do this to stop the curtain from catching.

The curtain tape should be ironed on first and the permanently sewn with the narrow strip facing upwards.

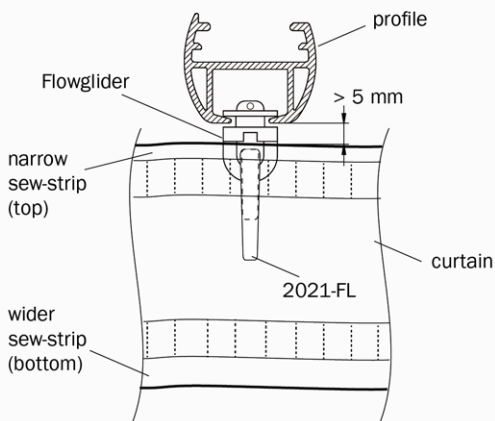

## Application example



Overview of various hand, cord and electrically operated situations. In the diagrams, the Flow parts are always shown with a symbol.

### Hand-drawn single package

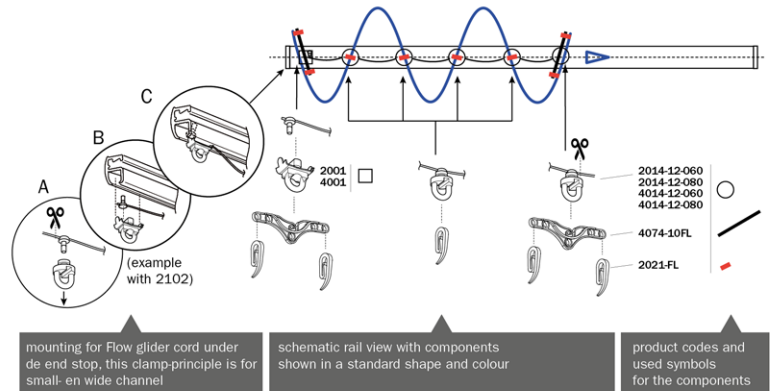

### Hand-drawn middle-closing

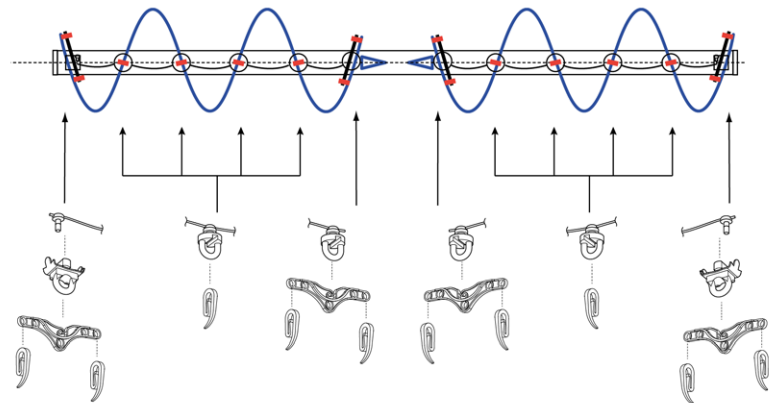

### 4014-22-060

60 mm band  
200% every 12 pockets  
250% every 15 pockets  
280% every 17 pockets

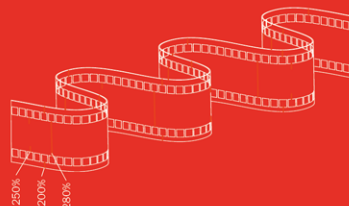

### 4014-22-080

80 mm band  
200% every 16 pockets  
250% every 20 pockets  
280% every 23 pockets

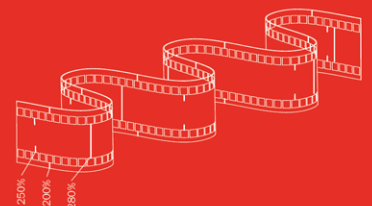

### Pleat sizes

#### 4014-22-060

band Flow for 60 mm gliders  
with adhesive

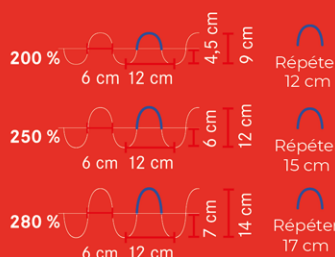

#### 4014-22-080

band Flow for 80 mm gliders  
with adhesive

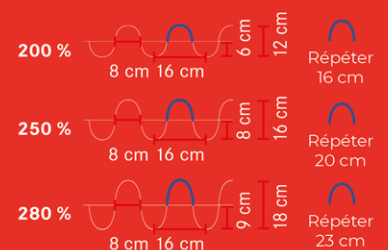

## Standard parts



### Curtain transport

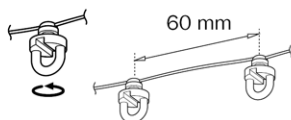

2014-12-060  
rotating glider on cord  
Flow small channel  
60mm

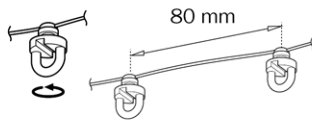

2014-12-080  
rotating glider on cord  
Flow small channel  
80mm

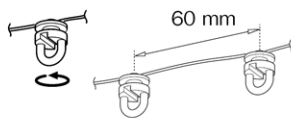

4014-12-060  
rotating glider on cord  
Flow wide channel  
60mm

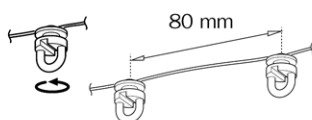

4014-12-080  
rotating glider on cord  
Flow wide channel  
80mm



4074-10FL  
pilot hook Flow white



2021-FL  
curtain hook Flow white



2001  
twist end stop  
white / grey / black



4001  
end stop  
white / grey / black

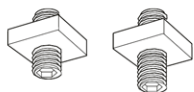

4002-08 5100 / 5300  
4002-16 5600 / 6200  
internal end stop



6009  
PRS glider, used as spacer  
behind overlap bracket

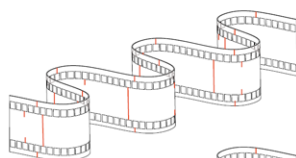

4014-22-060  
band Flow for 60 mm  
with adhesive

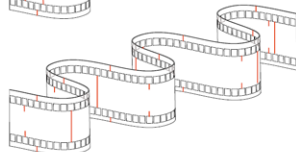

4014-22-080  
band Flow for 80 mm  
with adhesive

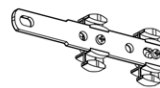

4075-1000  
carrier without overlap,  
a.o. for draw rod  
white / natural metallic / black

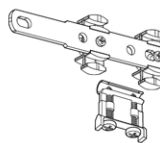

5175-3010  
carrier with overlap  
5100/5300 Flow  
white / natural metallic

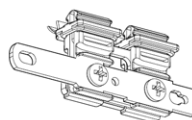

5675-3010  
carrier 5600 without overlap  
white / natural

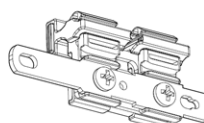

6275-3010  
carrier without overlap  
6200 Flow  
white / natural metallic / black



4074-30FL  
carrier with overlap  
Flow  
white / natural metallic / black

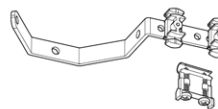

5174-30FL  
carrier with overlap  
5100/5300 Flow  
white / natural metallic



5674-30FL  
carrier with overlap  
5600 Flow  
white, natural metallic

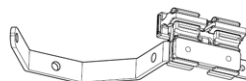

6274-30FL  
carrier with overlap Flow  
white / natural metallic / black

### Accessories



2004  
brake glider  
white / grey / black



7399  
plexiglass draw rod  
transparent

Technical specifications are subject to change without prior notice.  
Parts suitable for all rails, unless otherwise indicated.