



6200

electrically operated

for light, medium- and heavy-weight curtains

Luxurious and sturdy track

6200



electrically operated

for light, medium- and heavy-weight curtains

Luxurious and sturdy track

The Qurails 6200 electrically operated system is ultra-quiet and can be used for comfort or as part of an assisted living environment. The system can be integrated with many home automation systems, where it can be used to provide simulated occupancy, or as part of a scene setting. The 6200 system has proved to be a hugely popular track, used in a wide variety of situations, including hotels and hospitality venues, private residential properties, care homes, commercial office buildings and the healthcare sector.

- The ideal track for light, medium- or heavy curtains.
- Easy to bend and of exceptional quality.
- Can be equipped with one of the three different G-Motion motor versions.
- Curtains can be single, pair or multiple stack.
- Two systems can be connected with a concealed centre pulley to allow asymmetric stacking.
- Unieke hoekpouli maakt het mogelijk om twee rails op 90 graden aan te sluiten.
- Unique corner pulley allows two rails to be connected at 90 degrees.
- The motor is concealed from view by the curtain.
- Can be bent in different radii (horizontally and vertically).
- Compatible with the Goelst Flow or Swing System, for regularly pleated curtains.
- Silent and smooth running, also around bends.



Standard colours



High quality, wear-resistant Akzo Nobel coating, highly colourfast, UV resistant. Other RAL colours & special coatings on request.

Features

Material:	aluminium, powder coating
Colour:	white, natural metallic, black
Dimensions:	22 x 31 mm
Weight profile:	567 gr/m ¹
Mounting:	wall mounting, (suspended) ceiling mounting, ceiling system mounting, profile installation.

Profile specifications

Aluminium profile:

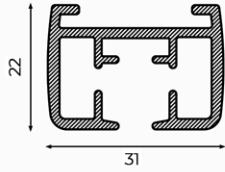

Kleuren met RAL-code en lengtes (m):

	RAL	4	5	6	7
white	9010	●		●	●
naturel metallic	9006	●		●	●
black	9005			●	

Mounting surface:

- wood
- stone
- concrete

Mounting:

- ceiling mounting
- wall mounting
- extension bracket
- built-in profile with flange (coming soon)

Bending:

bendingradius	bending tool
R 20 cm	1015
R 30 cm	1015
R 40 cm	*
R 50 cm	*
R > 80 cm	1018

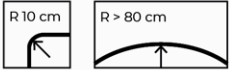

* To be bent by Qurails. Other radii available upon request.

Flow

The Qurails Flow System keeps pleats in curtains consistent. It can be used on both small and wide channel tracks and, because of a wide assortment of components, it can be used with manually, cord and electrically operated systems.

The Flow System can also be used with curved curtain tracks. For further information, see the Flow product data sheet.

Specification guide

Material

- Aluminium EN AW-6060-T66.
- Akzo Nobel powdered coating in accordance with the Qualicoat standard.

Mounting

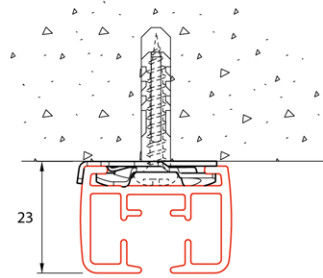

Ceiling mounting with fixing clamp 6050:
allow space for tightening the clamp

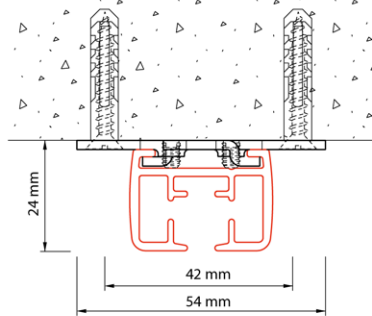

Ceiling mounting with bracket 6055-1000

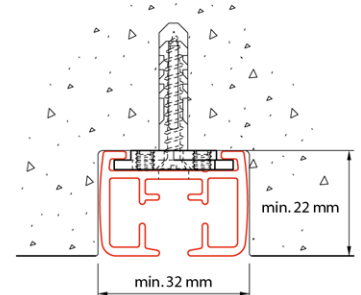

Concealed mounting on or in the ceiling with bracket 6055-2000.
For curved rails, use the profile as manufactured to determine the arc.

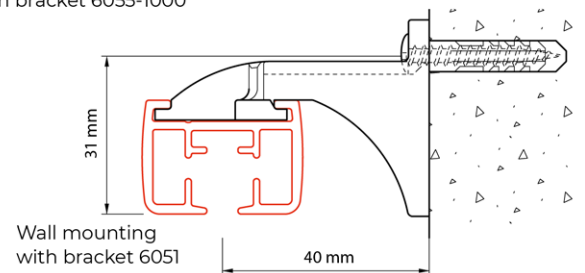

Wall mounting with bracket 6051

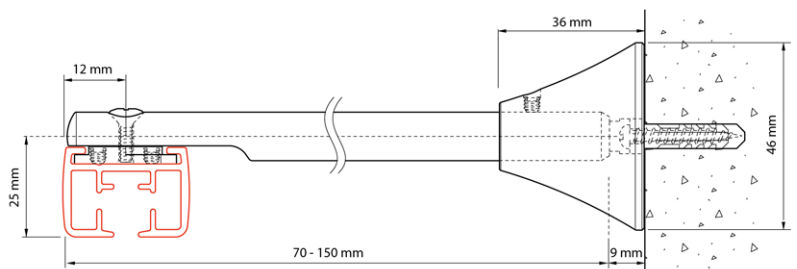

Wall mounting with adjustable extension bracket 6017, can be shortened from 15 to 7 cm.

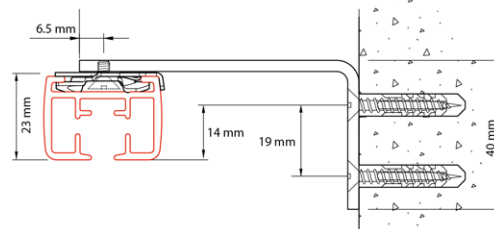

Wall mounting with 6015

6200 without head with 4010:

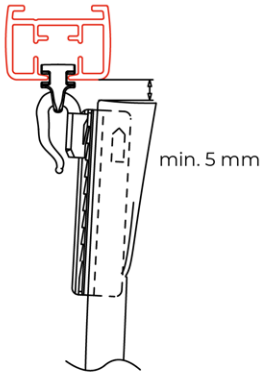

Example of curtain fabric:

With the fabric, make sure there is enough space between the curtain and the ceiling or between the curtain and the track.

6200 with 6010 glider to allow upstand heading:

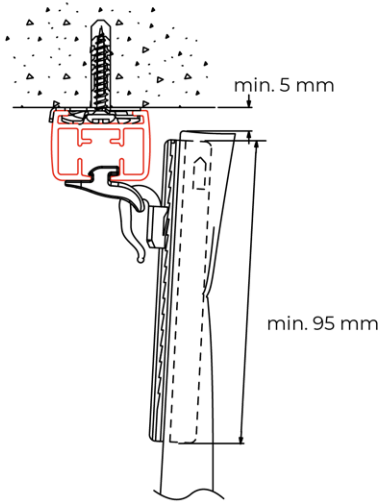

Mounting guideline

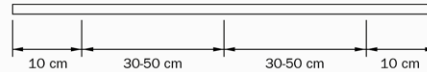

The distance between the brackets can vary depending on the following factors: the mounting surface (wood, concrete or plaster), the weight of the curtains and the curtain fabric production method, the specific application and the intensity of the use of the system. General advice: with the curtains open, place additional brackets where the pleats bunch together. Also place additional brackets before and after bends.



Load table

Load table G-Motion motor types

maximum curtain weight

motor type e.g. 'GM-4' motor type stands for: all motors with product code starting with GM-4		GM-4	GM-6	Tandem		GM-1	Tandem		
				GMT-6	GMT-6		GMT-1		
Bend	Glider	< 10 m / 33 ft	< 12 m / 39 ft	< 12 m / 39 ft	< 18 m / 59 ft	< 24 m / 79 ft	< 30 m / 98 ft		
Right	4010, 4020, 4030 6010	40 kg / 88 lbs	60 kg / 132 lbs 40 kg / 88 lbs	100 kg / 220 lbs	80 kg / 176 lbs	single 80 kg / 176 lbs	split 100 kg / 220 lbs	single 100 kg / 220 lbs	split 180 kg / 396 lbs
				60 kg / 132 lbs	-	-	-	-	-
1 curve or multiple curves ≤ 90° in total	4010, 4020, 4030 6010	30 kg / 66 lbs	50 kg / 110 lbs	90 kg / 198 lbs	70 kg / 154 lbs	70 kg / 154 lbs	90 kg / 198 lbs	90 kg / 198 lbs	170 kg / 374 lbs
			30 kg / 66 lbs	50 kg / 110 lbs	-	-	-	-	
2 curves 90° - 180° in total or large curve/oval	4010, 4020, 4030 6010	20 kg / 44 lbs	40 kg / 88 lbs	80 kg / 176 lbs	60 kg / 132 lbs	60 kg / 132 lbs	80 kg / 176 lbs	80 kg / 176 lbs	160 kg / 352 lbs
			20 kg / 44 lbs	40 kg / 88 lbs	-	-	-	-	
Motor-UP		yes	yes	yes	yes	no	no	no	no



Standard parts

System



G-motion GM-4
Motor unit
Max 40 kg

G-motion GM-6
Motor unit
Max 60 kg

G-motion GM-1
Motor unit
Max 100 kg

For more information on the motors refer to the G-Motion product data sheet.

Curtain transport

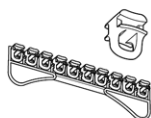

4010
glider
white / grey / black

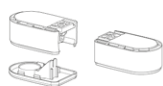

6271-1000
pulley set 6000
series, white /
grey / black

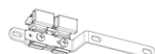

6274-3000
carrier with
overlap, white /
natural metallic /
black

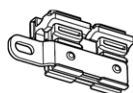

6275-3000
carrier without
overlap, white /
natural metallic /
black

Mounting



6050
ceiling fixing
clamp natural
incl. washer

Accessories

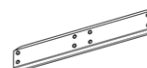

6052
connecting bridge
natural

Optional parts

System



6271-10UP
pulley set motor-
up left / right /
motor-up white

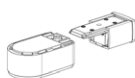

6272-1000
compact pulley
set white / grey /
black



6272-2000
intermediate
pulley, white /
grey / black

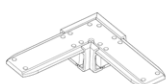

6272-2000-090
corner pulley

Curtain transport



4020
heavy duty glider
white / grey / black



4030
roller
white / black



6009
glider white for
Pilot Release
System (PRS)

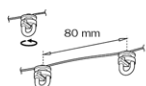

Flow glider
60 / 80 mm
see Flow product
data sheet



6010
projection glider
white / grey / black



6055-1000
ceiling fixing plate
white / natural
metallic / black



6055-3100-N-040
profile nut for
recessed fixing,
incl. Torx10 40mm



4055-30-20
mounting set
white / natural /
black

4055-40
suspension
hanger tube
1 side thread
50 / 100 / 150 cm,
white / natural /
black

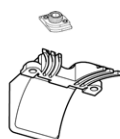

6051
wall bracket,
white / grey / black

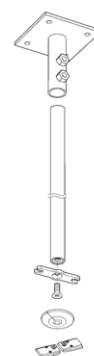

4064-10
base plate, white
/ natural metallic
/ black

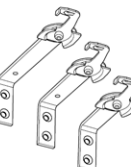

4064-40
hanger tube
70 / 120 / 150 / 200 cm
white / natural metallic



4064-30-20
mounting set
white

6015
extension bracket
5 / 7.5 / 10 / 15 cm,
white / natural
metallic / black



6017
extension bracket,
can be cut 7-15 cm
white / natural
metallic / black

Accessories

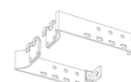

6059-1000
wall return set
15 cm white

Subject to technical changes.

Qurails[®]
Powered by GOELST.