

2200



montage

ceiling, wall

profile

2200
164 gr/m

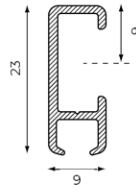

bending

radius cm
R 8 (1013)
R 10 (1012)
R 10 (1015)
R >80 (1018)

filler position

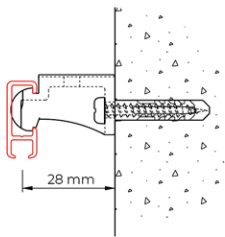

wall mounting with 2251

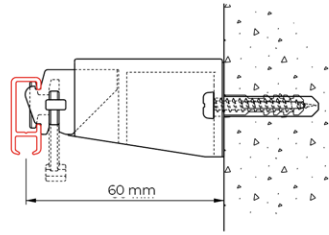

wall mounting using wall bracket 7451,

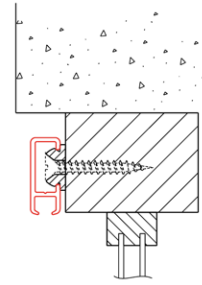

mounting on window sill with clip 2254

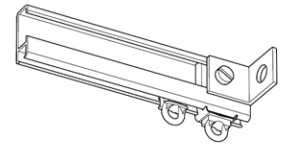

wall mounting with 2249-N

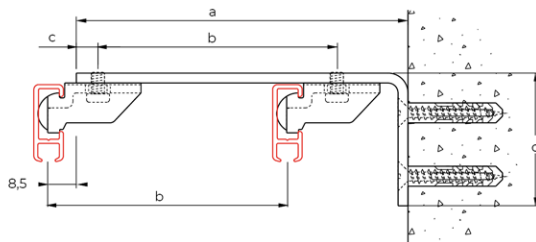

wall mounting with 2015 extension bracket and 2250 support

in mm	a	b	c	d
2015-05	50	-	6.5	40
2105-07.5	75	47	6.5	40
2015-10	100	72	6.5	40
2015-15	150	72	6.5	40
2018-15	150	57/57	6.5	60
2019-20	200	80	6.5	60
2019-25	250	80	6.5	60
2019-30	300	80	6.5	60

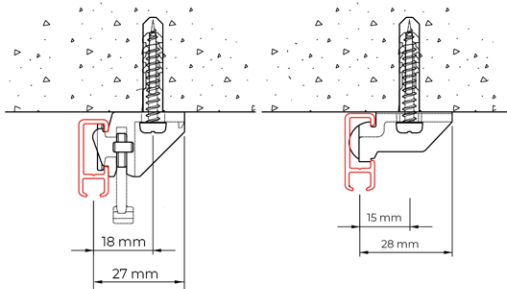

ceiling mounting with 7450, with quick release

ceiling mounting with 2250

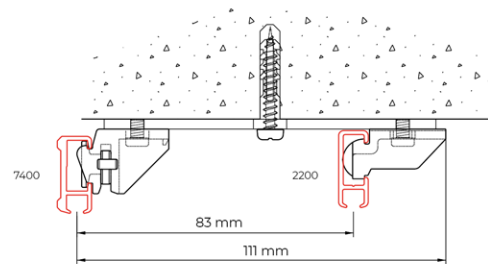

for perfect parallel mounting: use of double bracket 2216 with ceiling supports 7450 resp. 2250

Application example

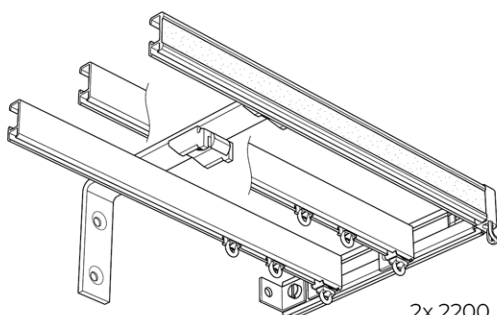

2x 2200 (sheers and curtains) combined with 7400 (volant), fixed to the heavy extension bracket 2018-15.

G-Norm

